

TECHNICAL INFORMATION

CITIZEN QUARTZ Cal. No. 05❖❖❖



(Cal. No. 0510)



(Cal. No. 0560)

 **CITIZEN**
CITIZEN IS A REGISTERED TRADEMARK OF CITIZEN WATCH CO., JAPAN.

Contents

§1. OUTLINE	1
§2. SPECIFICATIONS	1
§3. MAIN COMPONENTS	2
§4. SETTING THE WATCH	2
§5. SETTING THE DATE	3
§6. CHRONOGRAPH OPERATION	3
§7. ADJUSTING THE CHRONOGRAPH	4
§8. TACHYMETER	5
§9. AFTER CHANGING THE POWER CELL	5
§10. ARRANGEMENT OF WHEELS ON DIAL SIDE	6
§11. DISASSEMBLY AND ASSEMBLY OF THE MODULE	7
§12. TROUBLESHOOTING AND ADJUSTMENT	10

§1. OUTLINE

- CAL. 0510*** Analog quartz watch having a chronograph (Hour, minute, second) and a calendar.
- CAL. 0540*** Analog quartz watch having a chronograph (Minute, second) and a calendar.
- CAL. 0560*** Analog quartz watch having a chronograph (Hour, minute, second, 1/20 second) and a calendar.

§2. SPECIFICATIONS

Cal. No.		0510A-00	0540A-00	0560A-00
Type		Analog quartz watch		
Hands	Time system	Hour, minute, and small second hands	24-hour, hour, minute, and small second hands	Hour and minute hands
	Chronograph system	Hour, minute, and second hands	Minute and second hands	Hour, minute, second, and 1/20 second hands
Module size (mm)		ø29.1 x 4.1t		
Accuracy		±20 sec/month at 5°C to 35°C (41°F to 95°F)		
IC		C/MOS-LSI, 1 unit		
Operating temperature range		-10°C ~ +60°C (14°F ~ 140°F)		
Converter		Bipolar step motor, 2 units		Bipolar step motor, 3 units
Time adjustment		Impossible		
Measurement gate		10 sec		
Additional functions	Calendar (With quick setting device)	Date		
	Chronograph			
	Measurement unit	1 sec		1/20 sec
	Max. measurement indication	11 h, 59 min, 59 sec	59 min, 59 sec	11 h, 59 min, 59 sec, 95
Power cell	Part No. (Power cell No.)	280-44 (SR927W)		
	Nominal voltage/ Nominal capacity	1.55 V/60 mAH		
	Life time	Approx. 2 years		

§3. MAIN COMPONENTS

*C•G=ChronoGraph

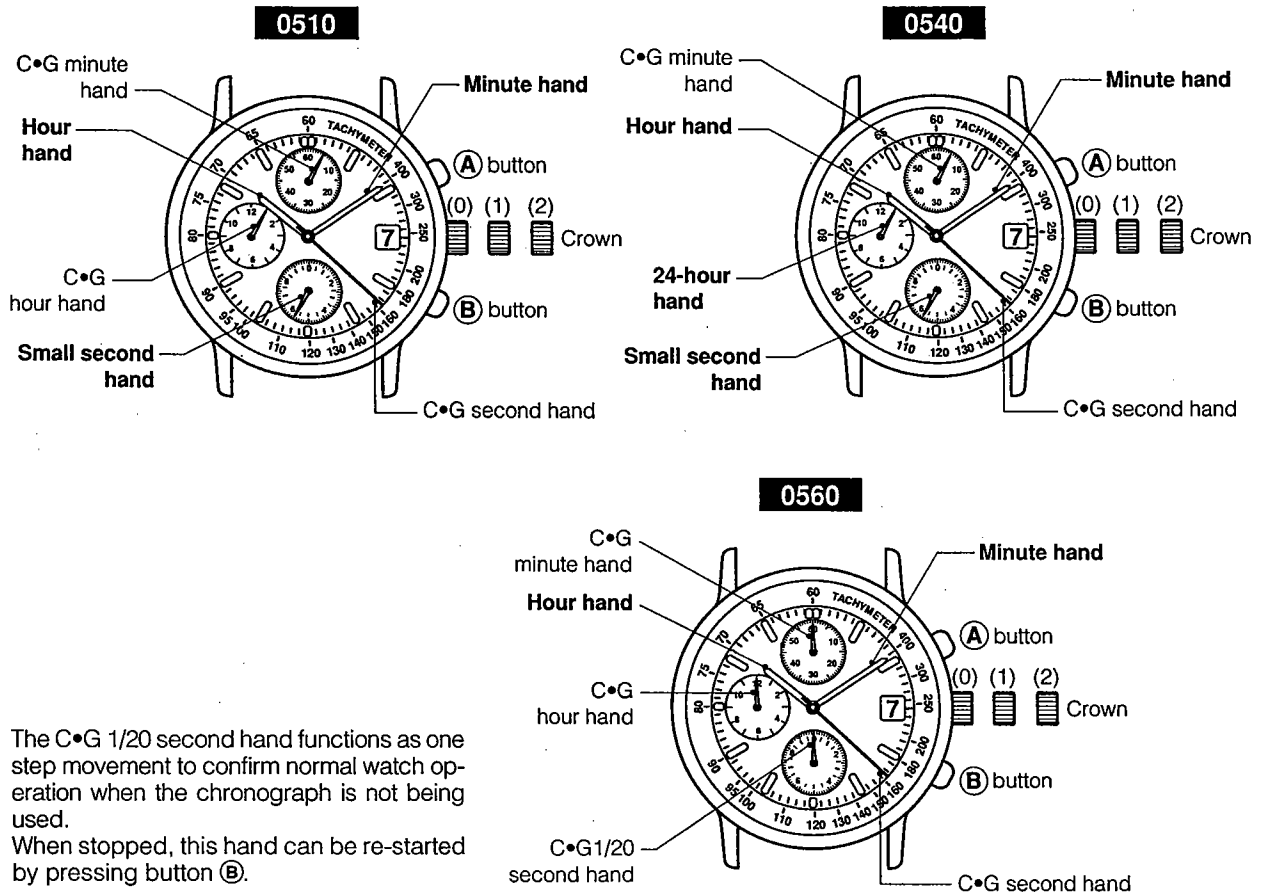

The C•G 1/20 second hand functions as one step movement to confirm normal watch operation when the chronograph is not being used. When stopped, this hand can be re-started by pressing button (B).

§4. SETTING THE WATCH

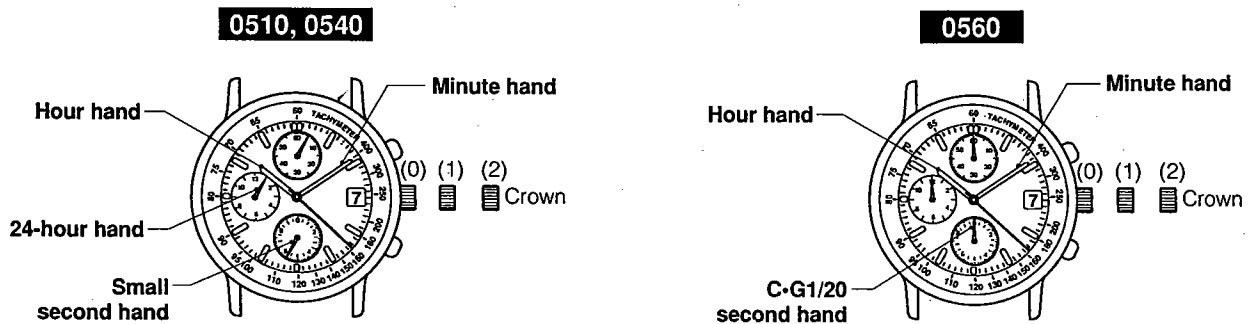

1. Wait till small second hand is on "0" sec, then crown to position (2) it stops the small second hand.
2. Turn the crown to set the minute/hour hands to the desired time.
 - * The 24-hour hand is synchronized with the hour hand. <0540>
 - Use the 24-hour time display as a reference to confirm a.m. and p.m. setting.
3. To start the small second hand, push the crown back to position (0).
 - * Reduction of power consumption: crown at (2) movement stop.

1. Pull the crown out to position (2).
2. Turn the crown to set the minute/hour hands to the desired time.
3. Push the crown back to position (0).
 - * Reduction of power consumption: crown at (2) movement stop.

§5. SETTING THE DATE

0150, 0540, 0560

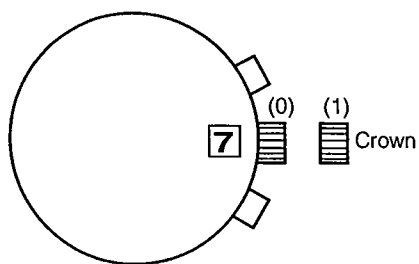

1. Pull out the crown to position (1).
 2. Turn the crown until the desired date appears.
- * Do not set the date between 9:00 PM and 1:00 AM otherwise, the date may not change properly.
3. The crown back to position (0) after set the date.

§6. CHRONOGRAPH OPERATION

0510

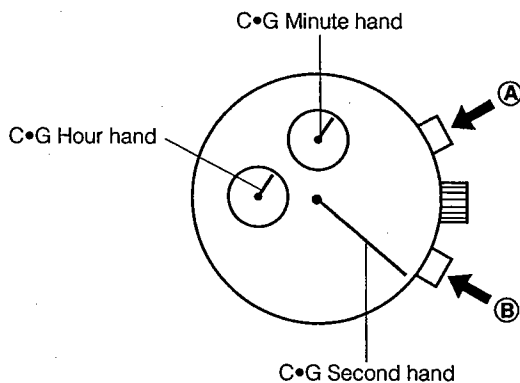

The chronograph can measure up to 12 hours in one second increments.

Standard measurement



Accumulated elapsed time measurement

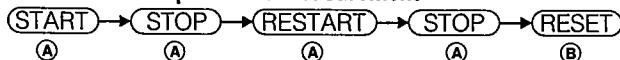

Can accumulate repeatedly by pressing (A)

0540

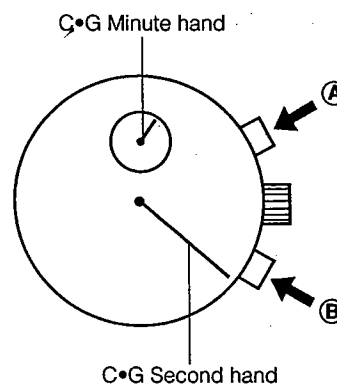

The chronograph can measure up to 60 minutes in one second increments.

Standard measurement

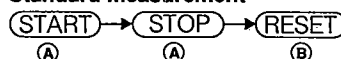

Accumulated elapsed time measurement

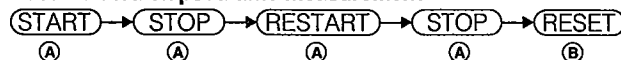

Can accumulate repeatedly by pressing (A)

0560

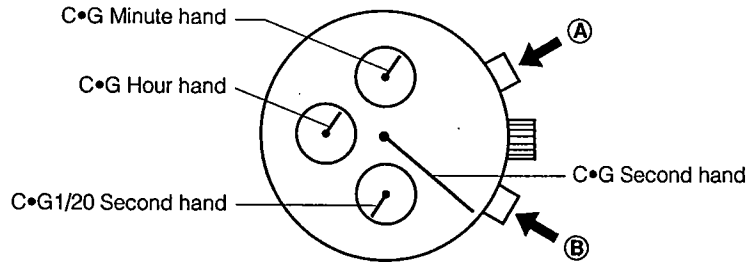

The chronograph can measure up to 12 hours in 1/20 (0.05) second increments.

Standard measurement



Accumulated elapsed time measurement



Can accumulate repeatedly by pressing (A)

The C•G 1/20 second hand will still indicate the correct time measurement even when the chronograph is started by pressing button (A) while the C•G 1/20 second hand is functioning as one step movement.

The C•G 1/20 second hand automatically stops at 00 second position 30 seconds after the chronograph is started.

When the chronograph is stopped by the (A) button, the C•G 1/20 second hand indicates the elapsed time.

When the (B) button is pressed again after the chronograph has been reset, the C•G 1/20 second hand start to function as one step movement to confirm watch operation.

* The hour/minute hands indicate the current time even when the chronograph is being used.

§7. ADJUSTING THE CHRONOGRAPH

If the chronograph hands do not return to "0" position when the chronograph is reset.

0510

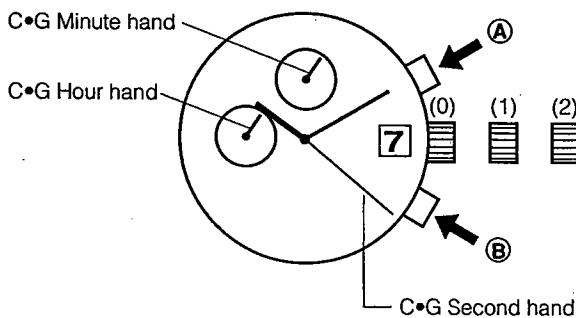

0540

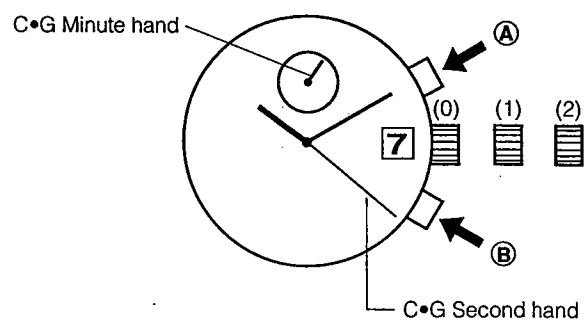

1. Pull out the crown to position (2) and then press button (A).

Adjusting the C•G second hand to "0" position.

* This second hand move quickly if the button (A) is pressed continuously.

2. Press the button (B) to reset minute/hour hands to "0" position.

3. Set the watch to current time.

4. Push the crown back to position (0).

0560

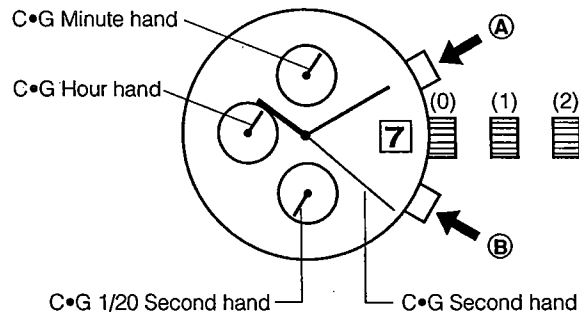

1. Pull out the crown to position (2), and press button (A).
Adjusting the C•G second hand to "0" position
* This second hand moves quickly if the (A) button is pressed continuously.
2. Pull out the crown to position (2), and then press button (B).
Adjusting the C•G 1/20 second hand at "0" position.
* This C•G 1/20 second hand moves quickly if the button (B) is pressed continuously.
3. Set the watch to current time.
4. Push the crown back to position "0".
5. Press the button (B) to reset minute/hour hands to "0" position.

§8. TACHYMETER

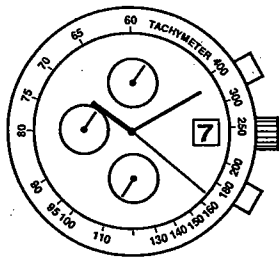

The tachymeter is the device which measures the speed of an automobile.

Knowing how many seconds the car covers a distance of 1 km, the meter can measure the approximate average speed per hour during a journey (up to the maximum measurable range of tachymeter is 60 seconds.)

If the chronograph is started at the same time as measurement, and stopped after 1 km, the average speed per hour can be determined according to the position of the second hand.

If the car covers the distance of 1 km in 45 seconds, the average hourly speed during the journey will be about 80 km.

§9. AFTER CHANGING THE POWER CELL (CAL. 0560)

After changing the power cell, please refer to the "Adjusting the Chronograph" section and set the correct hand position prior to use.

* This operation is required because the chronograph hands may not return to the 0 position when the chronograph is reset after changing the power cell.

§10. ARRANGEMENT OF WHEELS ON DIAL SIDE

CAL NO. 0510

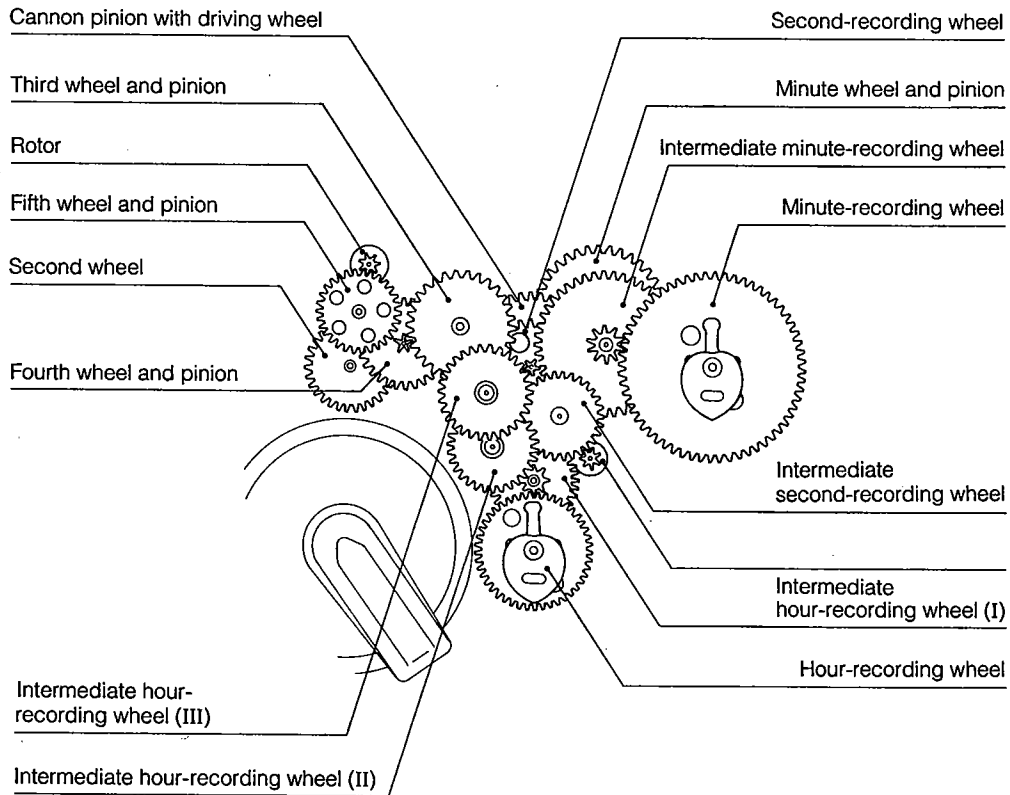

CAL NO. 0540

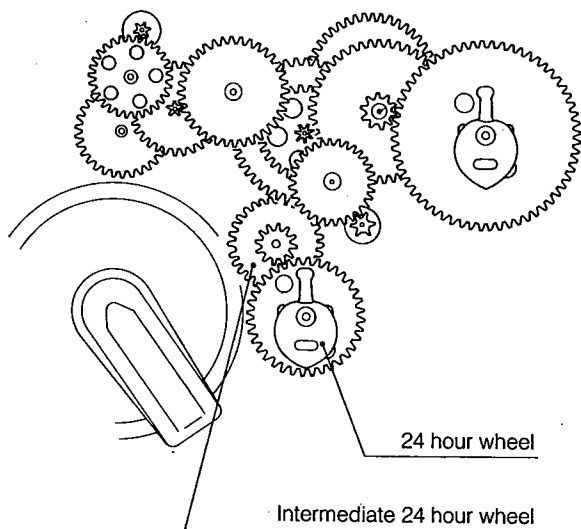

CAL NO. 0560

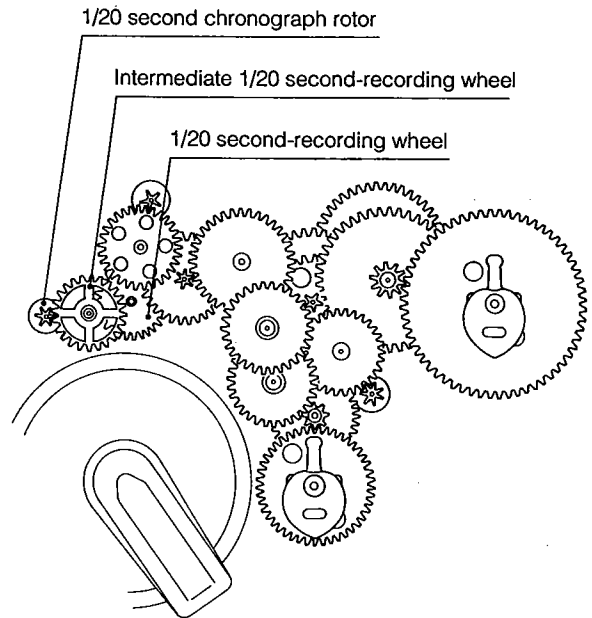

* All parts other than the above two parts are the same as CAL. 0510. The hour-recording wheel and intermediate hour-recording wheels (I), (II), and (III) of CAL. 0510 are not installed, however.

* All parts other than the above three parts are the same as CAL. 0510. The second wheel of CAL. 0510 is not installed, however.

§11. DISASSEMBLY AND ASSEMBLY OF THE MODULE

* The following is the development of CAL. 0510. Note that it is a little different from that of 0540/0560.

Disassemble procedure ① → ④⑧

Assemble procedure ④⑧ → ①

● Lubrication mark

Ⓐ : A-Lube oil

Ⓥ : V-Lube oil

ⓕ : F-Lube oil

Ⓞ : CH-1 oil

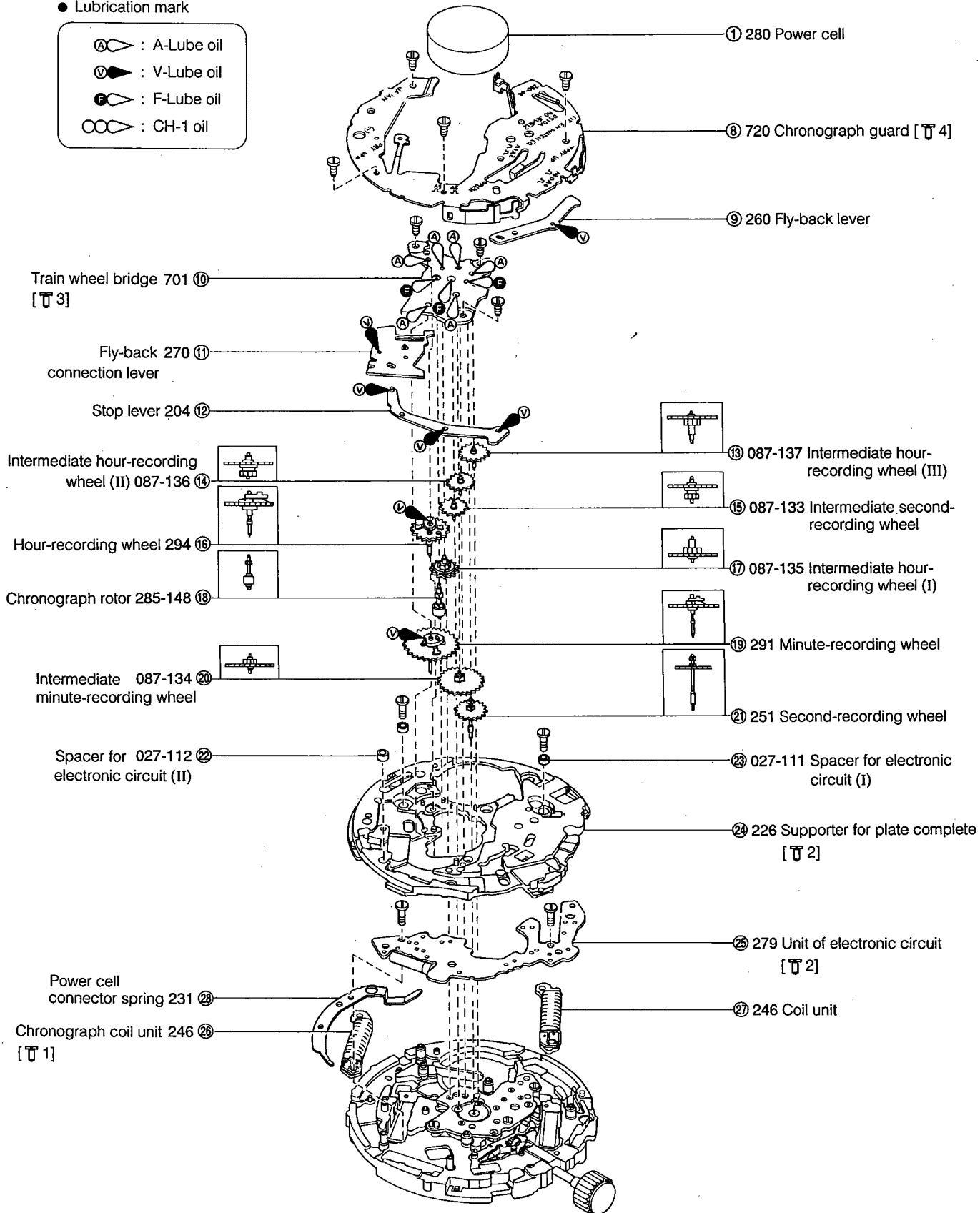

Center wheel cock 711 ⑳
[T 3]

Rotor 285-146 ㉑

Third wheel 017 and pinion ㉒

Second wheel 025 ㉓

Intermediate minute wheel 087-138 ㉔

Hour wheel 075 ㉕

Clutch wheel 064 ㉖

㉗ 084 Fifth wheel and pinion

㉘ 023 Fourth wheel and pinion

㉙ Cannon pinion 028 with driving wheel

㉚ 076 Setting wheel

㉛ 072 Minute wheel and pinion

㉜ 071 Yoke

㉝ 067 Setting lever

㉞ 087 Intermediate date correcting wheel

㉟ 212 Spacer for setting stem

㊱ 065 Setting stem

㊲ 190-126 Stator

㊳ 750 Metal plate

Chronograph stator 190-128 ㊴

CALIBER NO.

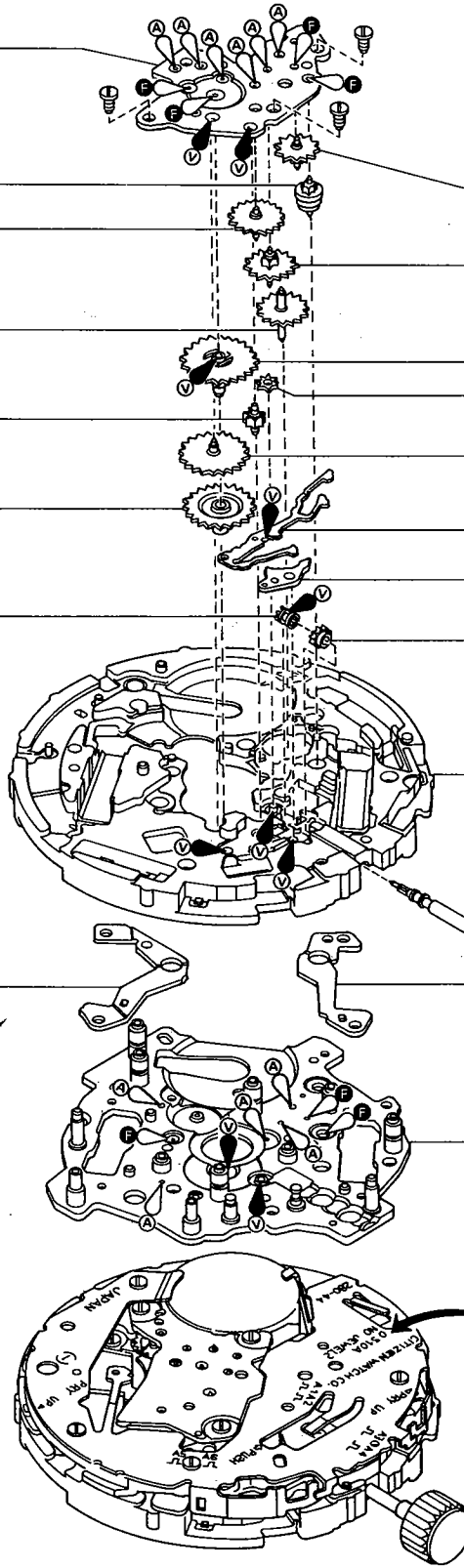

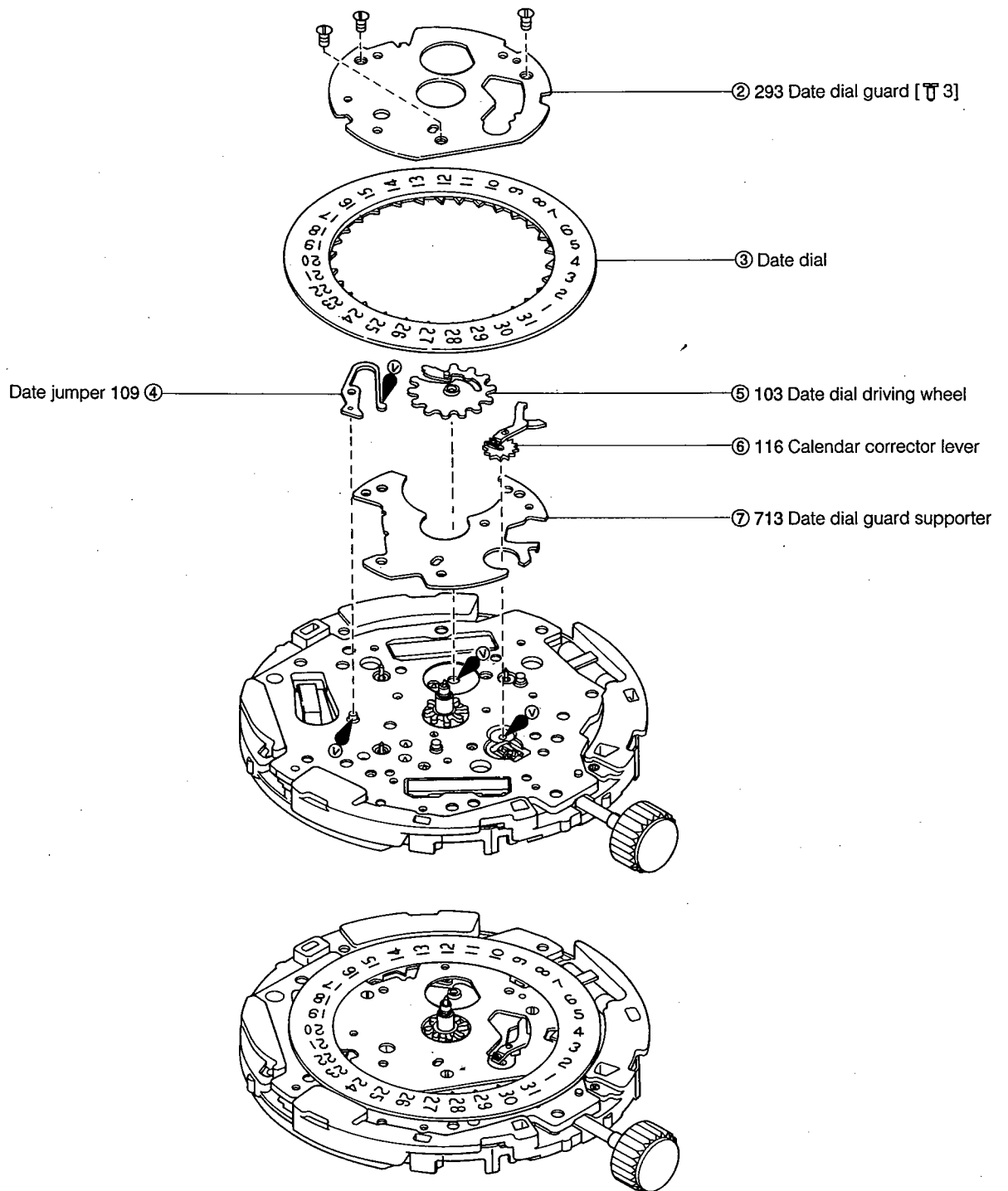

§12. TROUBLESHOOTING AND ADJUSTMENT

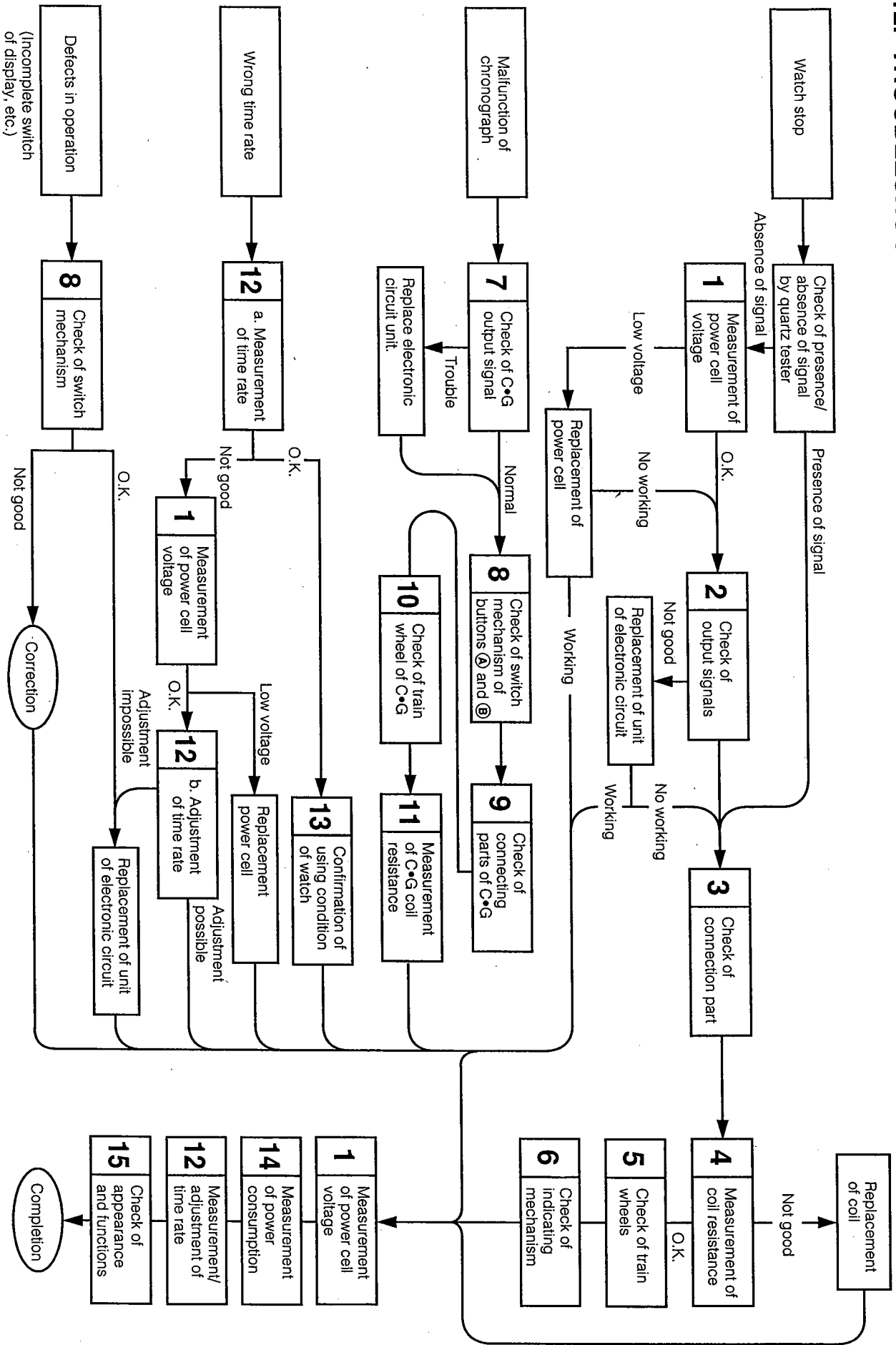

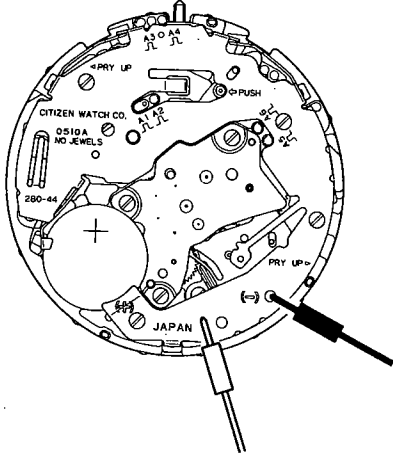
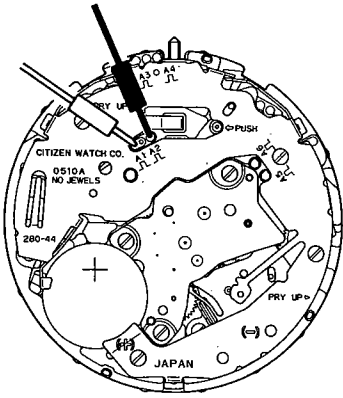
Check items	Method	Results and repair procedure
<p>① Measurement of power cell voltage</p>	<p>* Refer to Technical Manual, Basic Course II-1-a for the setting procedure of the tester.</p> <p style="text-align: right;"><Tester range: DC 3V></p> 	<ul style="list-style-type: none"> • Over 1.5 V → Non-defective • Under 1.5 V → Replace the power cell
<p>② Check of output signal</p>	<p>* Refer to Technical Manual, Basic Course II-1-b for the setting procedure of the tester.</p>  <p>This watch outputs the following signals.</p> <ul style="list-style-type: none"> • Output signals (A1\downarrow, A2\downarrow) of the time system (Second, minute, and hour) • Output signals (A3\downarrow, A4\downarrow) of the chronograph system (Second, minute, and hour) • Output signals (A5\downarrow, A6\downarrow) of the 1/20-sec chronograph system ... CAL. 0560 <p>If the watch stops, check the output signals A1\downarrow and A2\downarrow among the above signals.</p> <p>* Confirm that the crown is at the normal position (0 stage).</p>	<p>Output signals of A1 and A2</p> <ul style="list-style-type: none"> • Tester pointer moves to right and left from 0V every 1 sec. → Normal • Tester pointer does not moves. → Replace electronic circuit unit.
<p>③ Check of connection part</p>	<p>* Refer to the analog part of Technical Manual, Basic Course II-2-a.</p>	

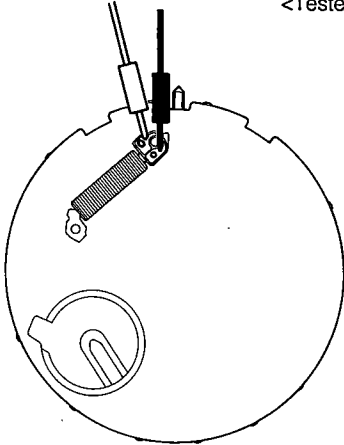
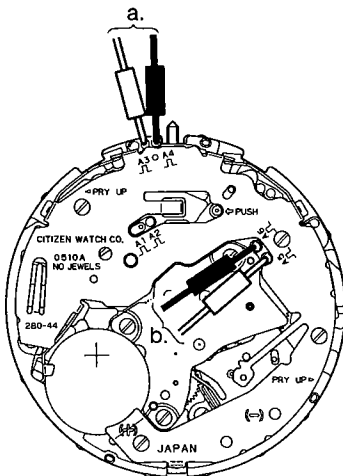
Check items	Method	Results and repair procedure
<p>④ Measurement of coil resistance</p>	<p>* Refer to Technical Manual, Basic Course II-1-c for the setting procedure of the tester.</p> <p style="text-align: right;"><Tester range: X10Ω></p> 	<p>1) Measurement of coil unit</p> <ul style="list-style-type: none"> • 1.7 kΩ~2.5 kΩ → Non-defective • Out of 1.7 kΩ~2.5 kΩ → Replace of coil unit
<p>⑤ Check of train wheel</p>	<p>* Refer to Technical Manual, Basic Course II-2-b.</p>	
<p>⑥ Check of indicating mechanism</p>	<ul style="list-style-type: none"> • Check the hour wheel, minute wheel and pinion, and second wheel and pinion. 	
<p>⑦ Check of output signals of C•G</p>	<p>* For the setting method of the tester, see Basic Section II-1-b.</p> <ul style="list-style-type: none"> • Check the output signals (A3μL, A4μL) to drive the step motor for the second, minute, and hour hands of the chronograph (Common to all CAL. 05 series). • Check the output signals (A5μL, A6μL) to drive the step motor for the 1/20 sec chronograph (CAL. 0560). <p>(Measuring method) Before measuring any of the above signals, start the chronograph. Since the output signal of the 1/20 sec chronograph stops 30 seconds after the start, measure it in this 30 seconds.</p> 	<p>a. Output signals of chronograph (Second, minute, and hour)</p> <ul style="list-style-type: none"> • Tester pointer moves to right and left from 0V every 1 sec. → Normal • Tester pointer does not move. → Replace electronic circuit unit. <p>b. Output signals of 1/20-sec chronograph (CAL 0560)</p> <ul style="list-style-type: none"> • Tester pointer jitters at 0V. → Moves little by little/bit by bit. • Tester pointer does not move. → Replace electronic circuit unit.

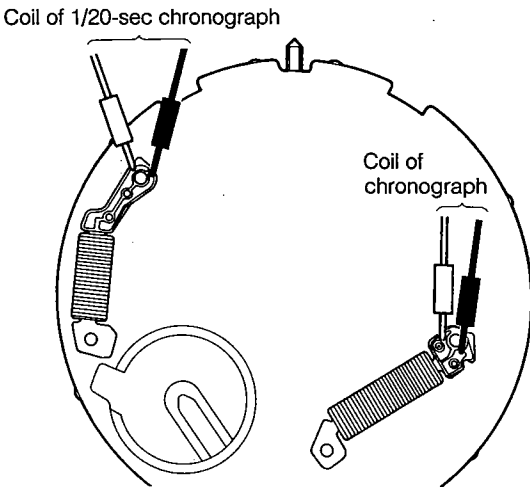
Check items	Method	Results and repair procedure
<p>8 Check of switch mechanism of buttons (A) and (B)</p>	<p>1) Confirm that the buttons (A) and (B) operate smoothly and check the switch springs of (A) and (B) for deformation.</p> <p>2) Check the part between the switch springs and pattern of the electronic circuit unit of dirt and dust.</p> <p>3) Confirm that the fly-back connection lever, stop lever, and flay-back lever are installed normally.</p>	<p>1) Buttons do not move smoothly.</p> <ul style="list-style-type: none"> • Dust or dirt → Clean. • Supply oil to push button packings again. • Deformation → Replace parts. <p>2) Dust or dirt → Clean</p>
<p>9 Check of train wheel of chronograph</p>	<p>* Refer to Technical Manual, Basic Course II-2-b.</p>	
<p>10 Check of connecting part of chronograph</p>	<p>* Refer to Technical Manual, Basic Course II-2-a.</p>	
<p>11 Measurement of coil resistance of chronograph</p>	<p>* Refer to Technical Manual, Basic Course II-1-c for the setting procedure of the tester.</p> <p>(Note that CAL. 0560 has also the coil of the 1/20-sec chronograph.)</p> 	<p>Coil of chronograph</p> <ul style="list-style-type: none"> • 1.7 kΩ ~ 2.4 kΩ → Normal • Out of 1.7 kΩ ~ 2.4 kΩ → Replace coil of chronograph. <p>Coil of 1/20-sec chronograph</p> <ul style="list-style-type: none"> • 1.9 kΩ ~ 2.6 kΩ → Normal • Out of 1.9 kΩ ~ 2.6 kΩ → Replace coil of 1/20-sec chronograph.
<p>12 Measurement/adjustment of time rate</p>	<p>* Refer to Technical Manual, Basic Course II-2-d.</p>	
<p>13 Confirmation of using condition of watch</p>	<p>* Refer to Technical Manual, Basic Course II-2-e.</p>	

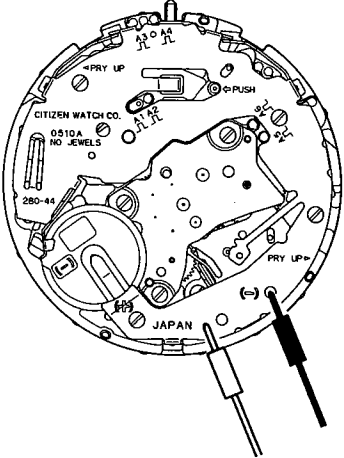
Check items	Method	Results and repair procedure
<p>14 Measurement of current consumption</p>	<p>* Refer to Technical Manual, Basic Course II-1-f for the setting procedure of the teste.</p> <p>1. Measurement of normal time display</p>  <p>2. Measurement while chronograph is operating</p> <p>* Set the tester and measure the current similarly to 1.</p> <p>1) In case of CAL. 0510, and 0540 Select the tester range of 10 μA or 12 μA.</p> <p>2) In case of CAL. 560 Select the tester range of 1 mA or 600 μA.</p> <p><Measuring method> Push the switch corresponding to the button (A) to start the chronograph hands (to drive the chronograph train wheel), the measure the current.</p> <p>Since the 1/20 sec chronograph hand of CAL. 0560 stops 30 seconds after the start, measure the current in this 30 seconds.</p> <p>3. Measurement of electronic circuit unit</p> <p>* Set the tester similarly to 1.</p>	<p>1. Normal time display</p> <ul style="list-style-type: none"> • Under 1.6 μA → Non-defective • Over 1.6 μA → Measure the electronic circuit unit separately. <p>2. While chronograph is in operation</p> <p>1) CAL. 0510, 0540</p> <ul style="list-style-type: none"> • Under 3.8 μA → Non-defective • Over 3.8 μA → Measure electronic circuit unit. <p>2) CAL. 0560</p> <ul style="list-style-type: none"> • Under 160 μA → Non-defective • Over 160 μA → Measure electronic circuit unit. <p>3) Measurement of electronic circuit unit</p> <ul style="list-style-type: none"> • Under 0.3 μA → Non-defective • Over 0.3 μA → Replace the electronic circuit unit.
<p>15 Check of appearance and functions</p>	<p>* Refer to Technical Manual, Basic Course II-2-f.</p>	